

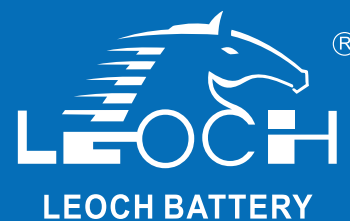

LPF Series-Front Terminal

LPF12-200(12V200Ah)



Specifications

Rated Voltage	12V	
Nominal Capacity	$C_{10}, 1.80V/cell$	200.0Ah
Dimension	Length	560±2mm (22.05 inches)
	Width	125±1.5mm (4.92 inches)
	Container Height	320±2mm (12.60 inches)
	Total Height	320±2mm (12.60 inches)
Approx Weight	59.5 Kg (131.1 lbs)	
Terminal	M8	
Container Material	ABS	
Rated Capacity (25°C)	210.0 Ah	(20hr, 10.5A, 1.80V/cell)
	200.0 Ah	(10hr, 20.0A, 1.80V/cell)
	195.2 Ah	(8hr, 24.4A, 1.75V/cell)
	175.0 Ah	(5hr, 35.0A, 1.75V/cell)
	118.1 Ah	(1hr, 118.1A, 1.67V/cell)
Max. Discharge Current	2000A (5s)	
Internal Resistance (25°C)	Approx 3.0mΩ	
Operating Temp. Range	Discharge	-15 ~ 50°C (5 ~ 122°F)
	Charge	0 ~ 40°C (32 ~ 104°F)
	Storage	-15 ~ 40°C (5 ~ 104°F)
Nominal Operating Temp. Range	25±3°C (77±5°F)	
Cycle Use	Initial Charging Current less than 60.0A. Voltage 14.1V~14.4V at 25°C(77°F)Temp. Coefficient -30mV/°C	
	Standby Use	
Effect of temp. to Capacity	Initial Charging Current less than 60.0A. Voltage 13.5V~13.8V at 25°C(77°F)Temp. Coefficient -20mV/°C	
	40°C (104°F)	103%
	25°C (77°F)	100%
Self Discharge	0°C (32°F)	86%
	LPF series batteries may be stored for up to 6 months at 25°C(77°F) and then a freshening charge is required. For higher temperatures the time interval will be shorter.	

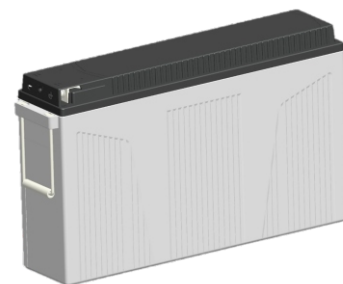

Layout

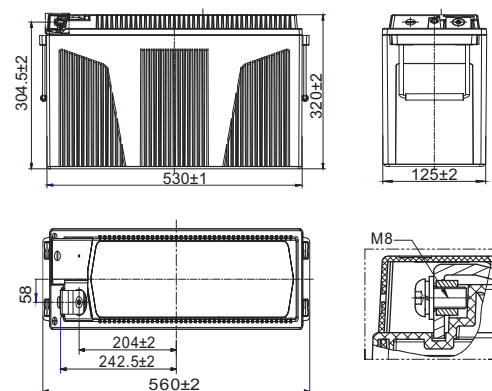

Constant Current Discharge (Amperes) at 25 °C (77°F)

F.V/Time	10min	15min	20min	30min	45min	1h	2h	3h	4h	5h	6h	8h	10h	20h
1.85V/cell	287.5	256.2	226.7	185.7	143.2	97.3	63.3	47.7	38.0	31.8	28.7	22.4	18.7	9.80
1.80V/cell	334.0	298.0	252.9	199.6	151.4	107.6	68.8	51.6	41.0	34.2	29.5	23.7	20.0	10.5
1.75V/cell	368.6	315.2	269.6	207.6	156.1	111.3	70.9	53.0	42.0	35.0	29.9	24.4	20.3	10.7
1.70V/cell	392.5	333.1	280.4	214.7	159.1	115.7	73.2	54.6	43.1	35.8	30.3	24.9	20.6	10.8
1.67V/cell	410.4	343.6	286.3	219.1	162.5	118.1	74.4	55.4	43.7	36.2	30.6	25.1	20.8	10.9
1.60V/cell	428.3	368.0	294.7	223.5	164.9	123.9	77.5	57.4	45.1	37.4	30.9	25.7	21.3	11.2

Constant Power Discharge (Watts/cell) at 25 °C (77°F)

F.V/Time	10min	15min	20min	30min	45min	1h	2h	3h	4h	5h	6h	8h	10h	20h
1.85V/cell	536.8	491.0	431.8	357.7	278.0	188.6	123.3	93.3	74.5	62.4	57.1	44.2	37.0	19.8
1.80V/cell	616.5	565.0	474.8	378.7	291.7	207.3	133.5	100.6	80.0	67.0	58.3	46.6	40.0	21.0
1.75V/cell	669.5	591.5	501.3	390.5	298.1	212.9	136.8	102.8	81.7	68.3	59.0	48.0	40.0	21.2
1.70V/cell	696.9	618.1	517.4	401.8	302.5	219.8	140.5	105.3	83.5	69.7	59.7	48.7	40.5	21.4
1.67V/cell	725.8	639.2	526.3	409.1	308.1	223.3	142.3	106.6	84.5	70.4	60.1	49.2	40.8	21.5
1.60V/cell	736.6	666.4	534.0	411.9	309.2	231.9	147.2	109.9	86.8	72.2	60.4	50.2	41.6	21.9



LPF Series-Front Terminal

LPF12-200(12V200Ah)



Applications

- UPS
- For standard power cabinet
- Network connection equipment of communication system
- Power system of special network of local area network
- Power station systems

General Features

- 12 years design life(25°C)
- Specifically ideal for 19 inches or 23 inches power cabinets
- Front terminals make the installation, maintenance and supervision easy
- Shield designs protect terminals from short circuit and show good appearance
- Unique vent valve design: reduce water losing and prevent air/spark going inside

Standards

- Compliance with IEC 60896 standards, EU Battery Directive
- UL, CE Certified
- Manufactured in Leoch@TS16949, OHSAS 18001, ISO 9001 and ISO 14001 certified production facilities

Discharge Characteristics

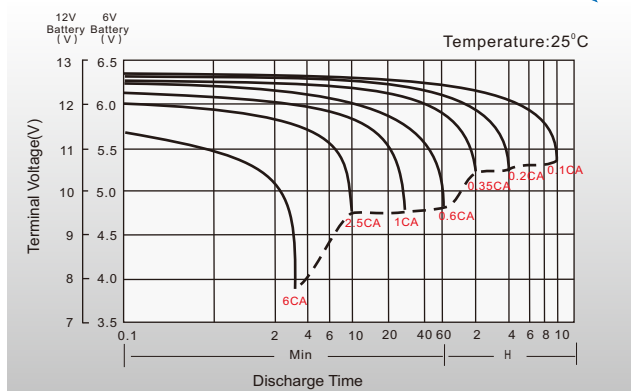

Float Charging Characteristics

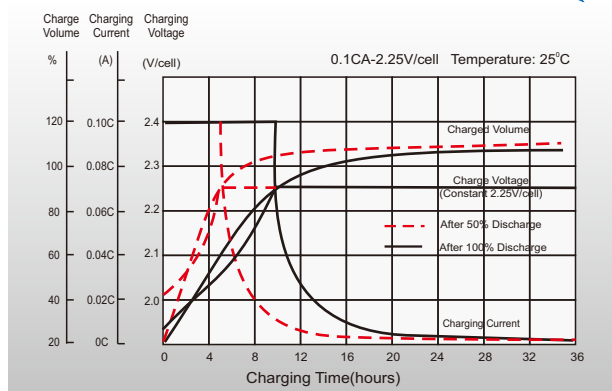

Temperature Effects in Relation to Battery Capacity

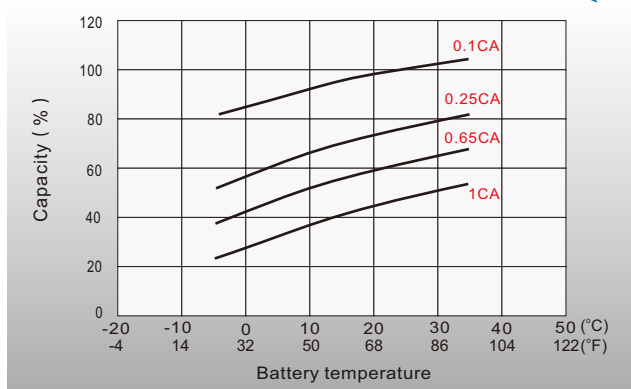

Effect of Temperature on Long Term Float Life

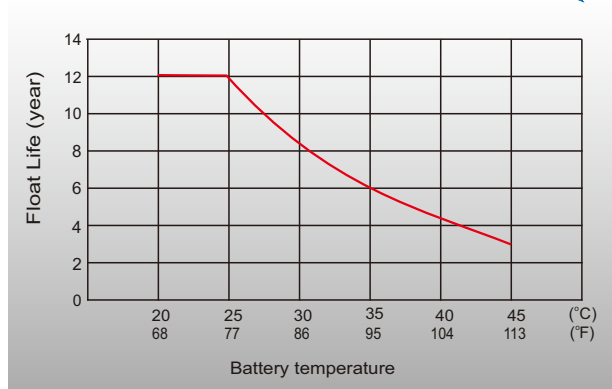

Sales Offices Worldwide

China Sales Office
5th Floor, Xinbaohui Bldg., Nanhai Blvd.,
Nanshan, Shenzhen, China. 518052
Tel: +86-755-86036060 (100 lines)
Fax: +86-755-26067269
E-mail: export@leoch.com

HongKong Sales Office
Workshop C, 33/F, TML Tower, No. 3 Hoi Shing Road,
Tsuen Wan, New Territories, Hong Kong
Tel: +852 35786666
Fax: +44 1452 690125
E-mail: sales.hk@leoch.com

Singapore Sales Office
No. 1 Tech Park Crescent,
Singapore 638131
Tel: +65 68636078
Fax: +65 6863 6079
Email: sales.sg@Leoch.com

Australia Sales Office
2 /29 Tarlington Place, Smithfield. NSW 2164
Australia
Tel: 02 9756 0950
E-mail: sales.au@leoch.com

North America Sales Office
19751 Descartes
Foothill Ranch, CA 92610, USA
Tel: 949-588-5853
Fax: 949-588-5966
E-mail: sales@leoch.us

UK Sales Office
9B Wheatstone Court. Waterwells, Business Park,
Gloucester, GL2-2AQ, UK United Kingdom
Tel: +44(0) 1452 729428 / 1452 729696
Fax: +44 1452 690125
E-mail: Sales.Europe@leoch.com

EMEA Sales Office
1 Deligiorgi St., 121 31 Athens,
Greece
Tel: +30 210 5760318 (2 lines)
E-mail: support_EMEA@leoch.com

India Sales Office
Shed no.A-53(b), 2nd Stage of Peenya Industrial Area,
Bangalore North Taluk, Bangalore-560058, India
Tel: +91-80-23440018/23440019
Fax: +91-80-23440017
E-mail: indiasales@leoch.com



[Http://www.leoch.com](http://www.leoch.com)
[Http://www.leoch.us](http://www.leoch.us)

© 2018 LEOCH. All rights reserved.
Trademarks and logos are the property of LEOCH and its affiliates unless otherwise noted.
Subject to revisions without prior notice.

Publication No.: LB-LPF12-200-PD-EN-V1.1-201904